

ANNEX

A

ENGLISH/FRENCH PICTURE DICTIONARY

PISTOL
PISTOLET

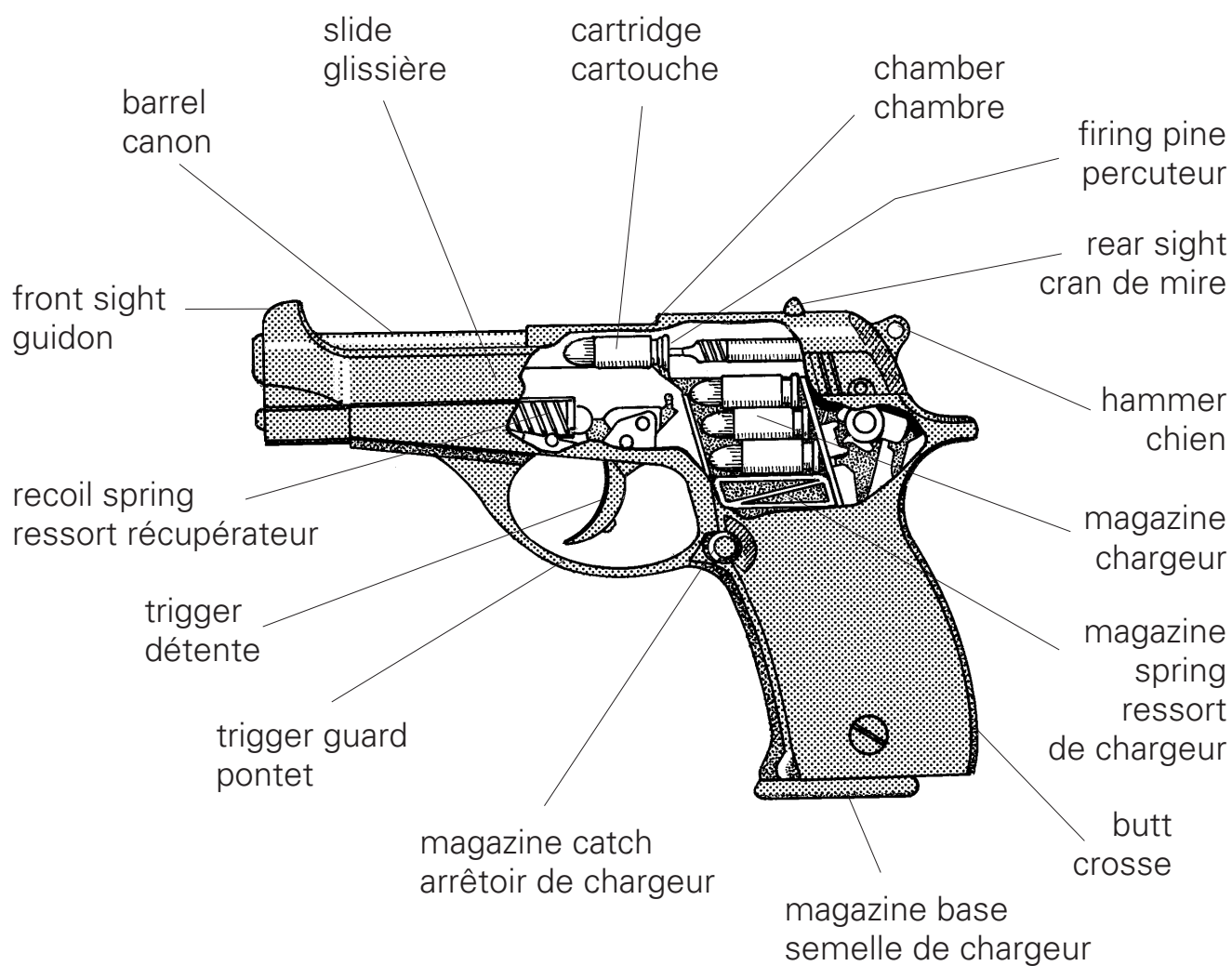
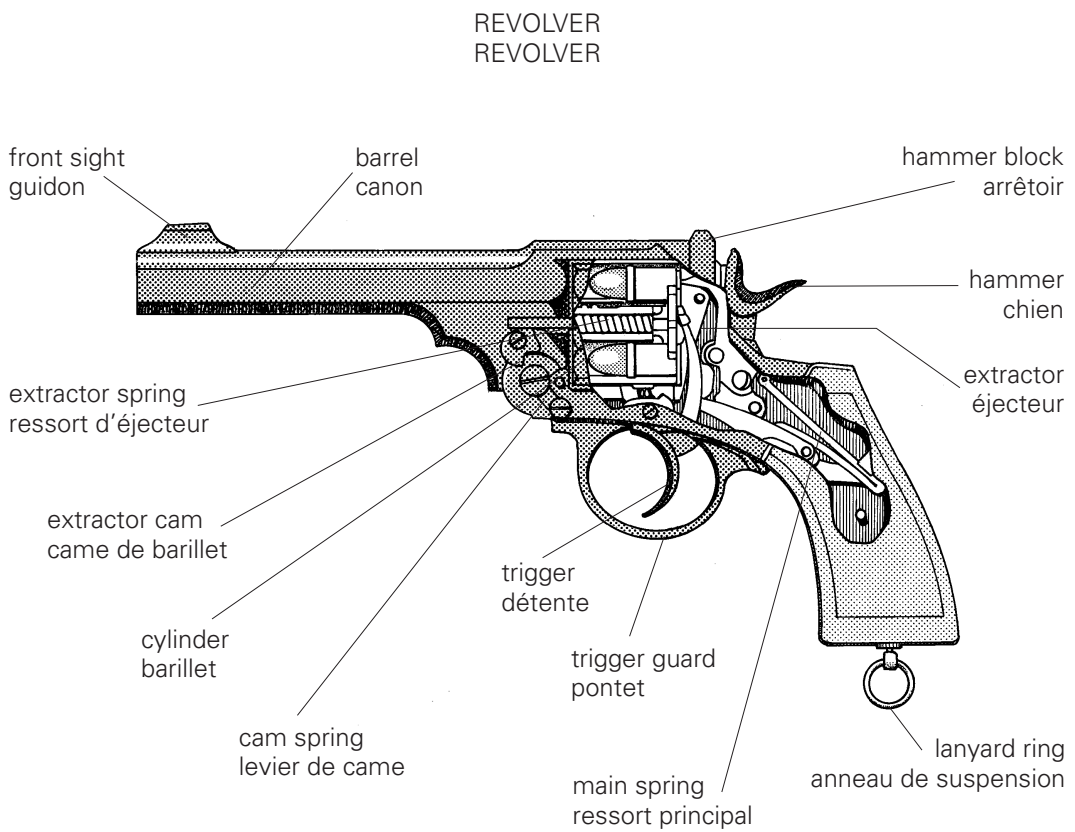

SUBMACHINE GUN
PISTOLET-MITRAILLEUR

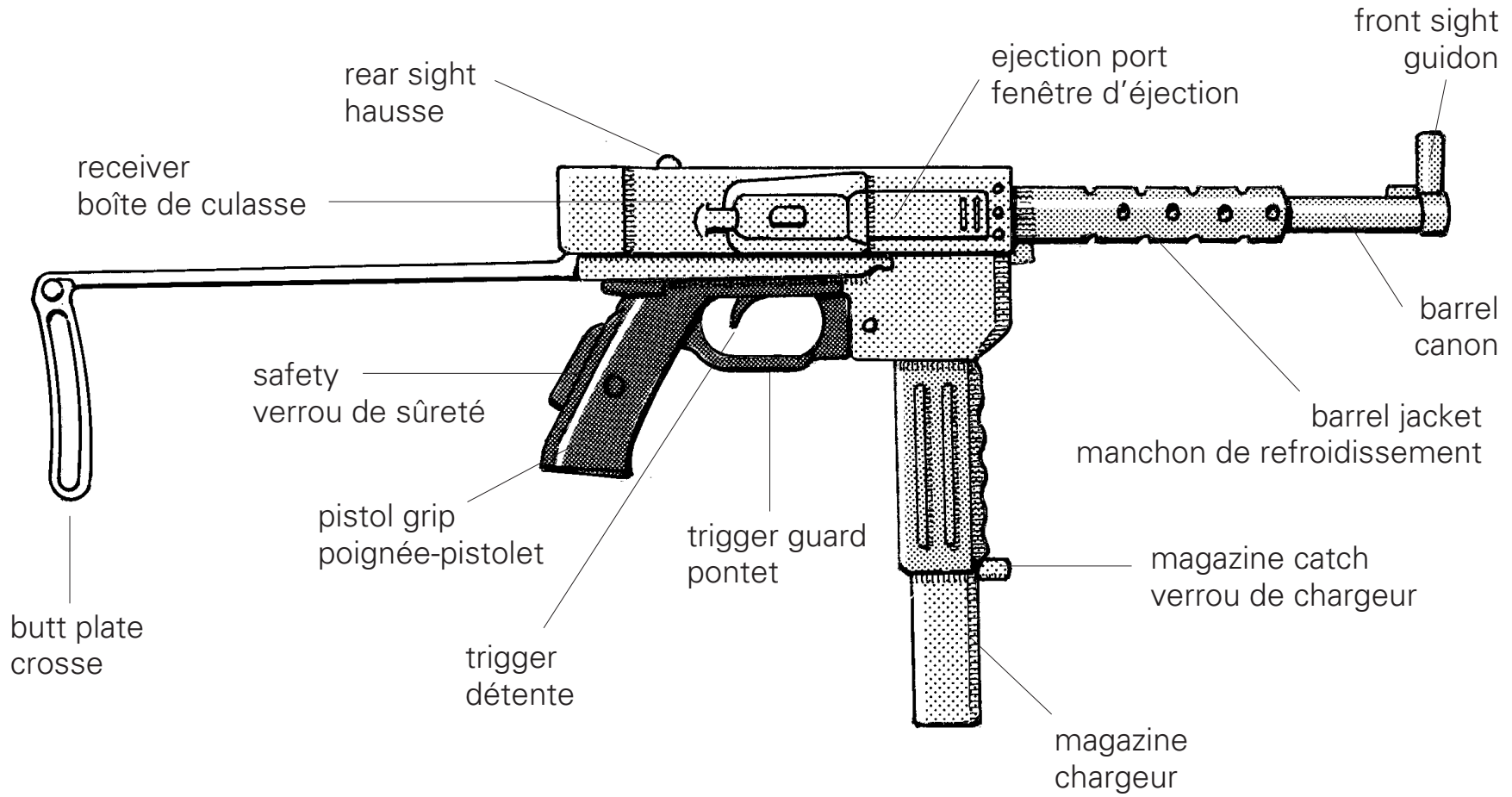

AUTOMATIC RIFLE
FUSIL AUTOMATIQUE

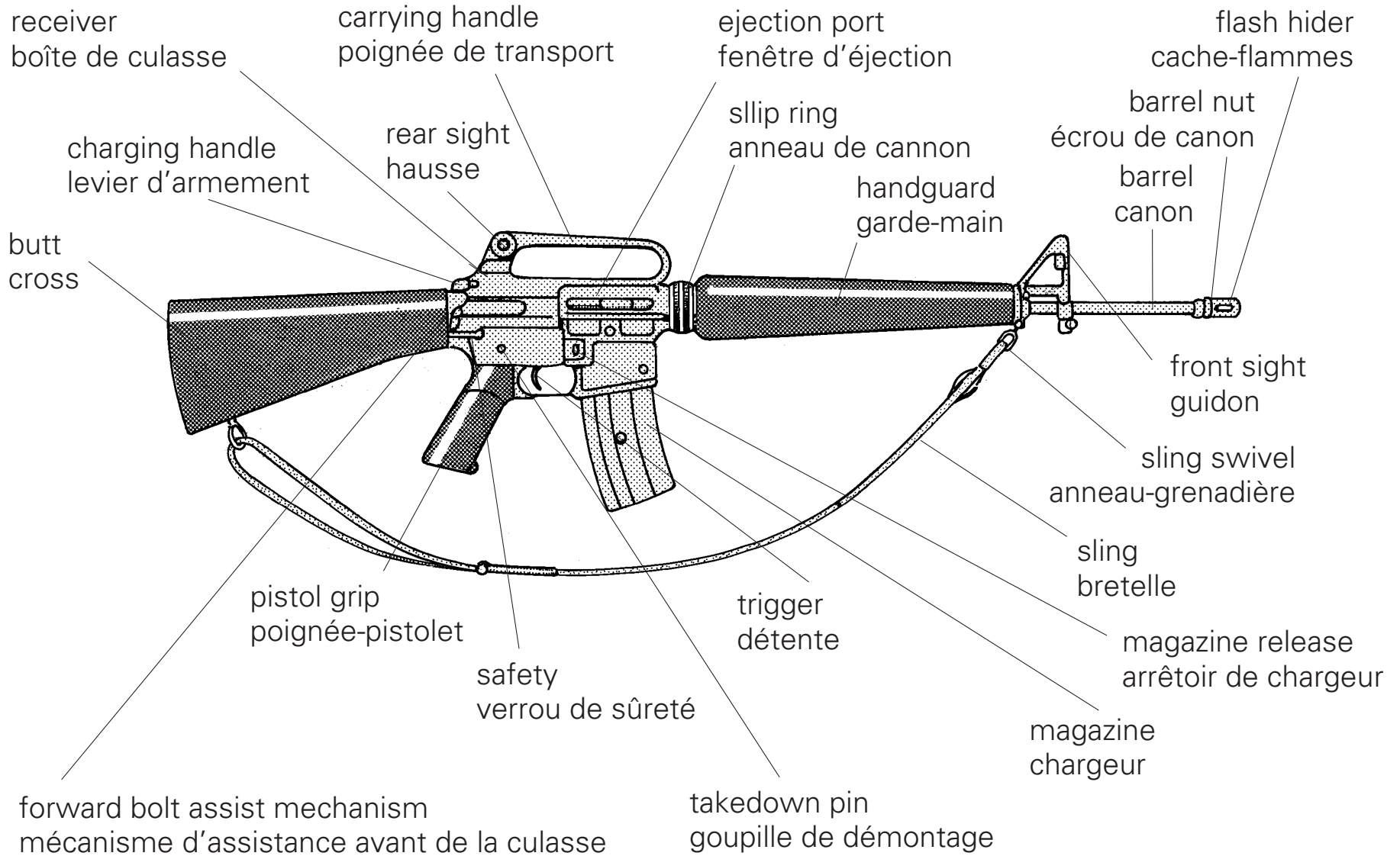

LIGHT MACHINE GUN
FUSIL-MITRAILLEUR

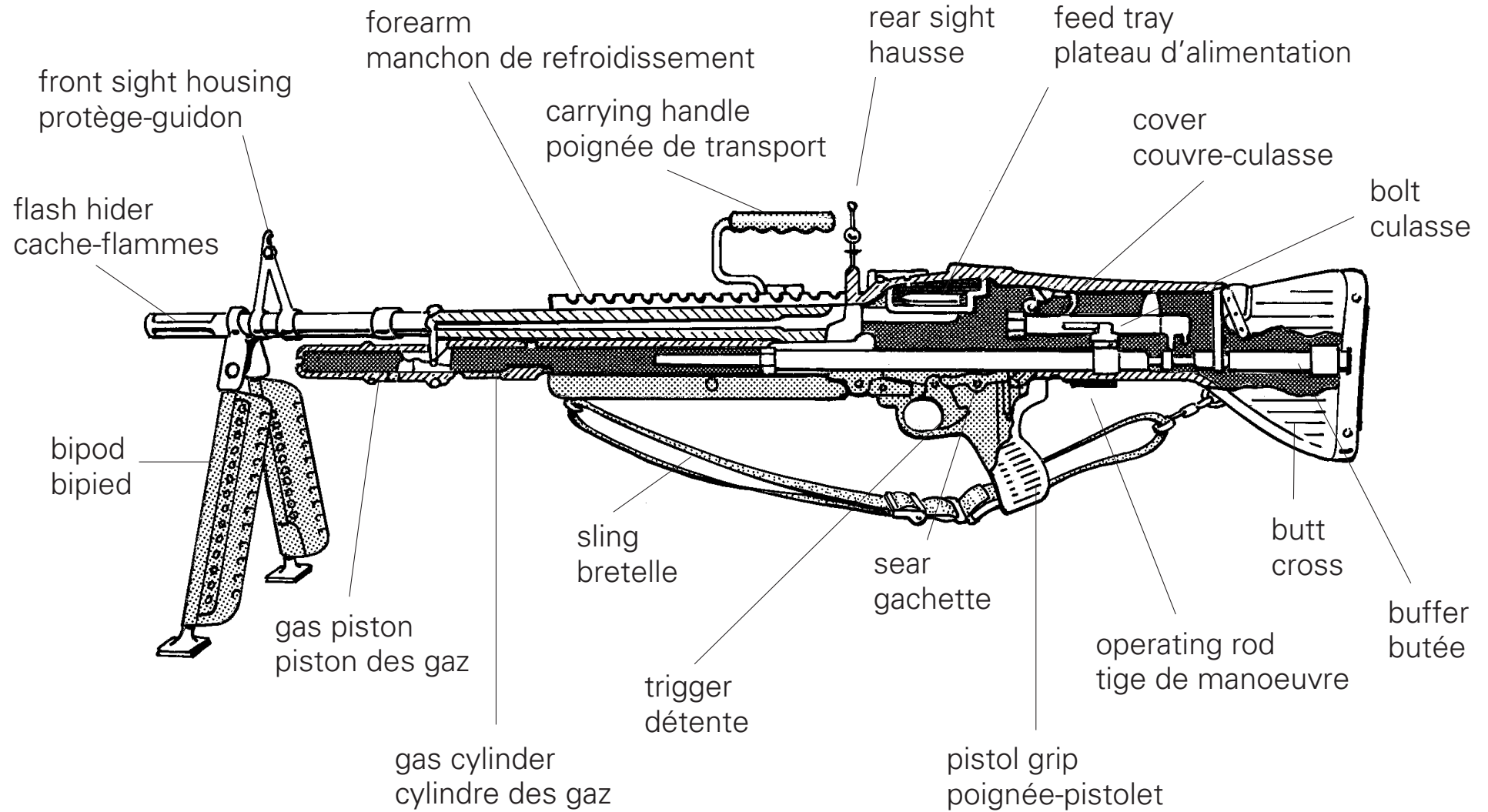

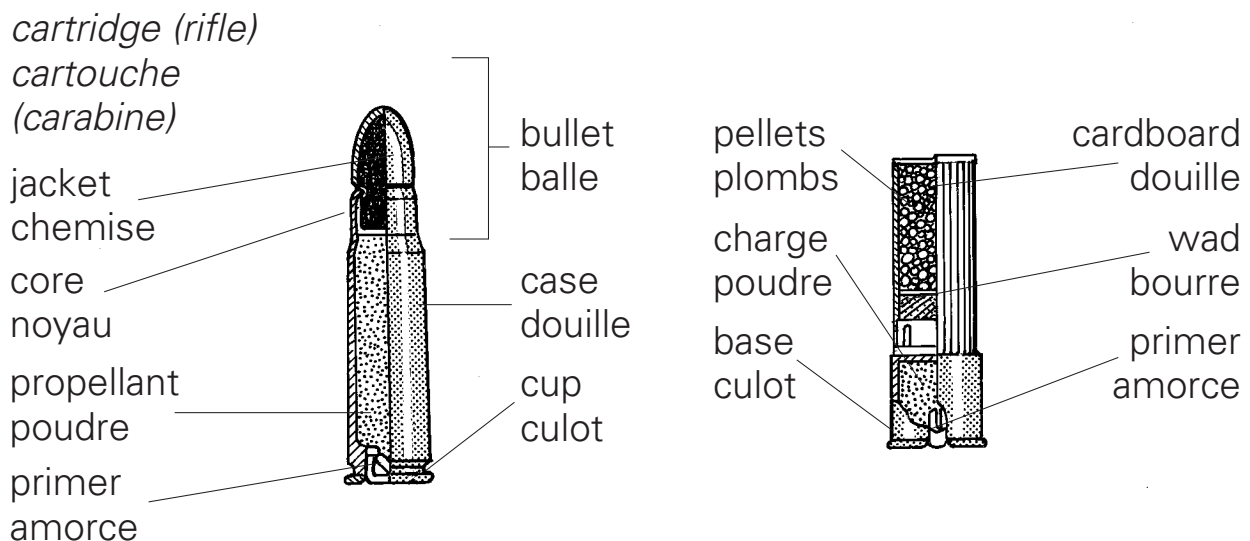
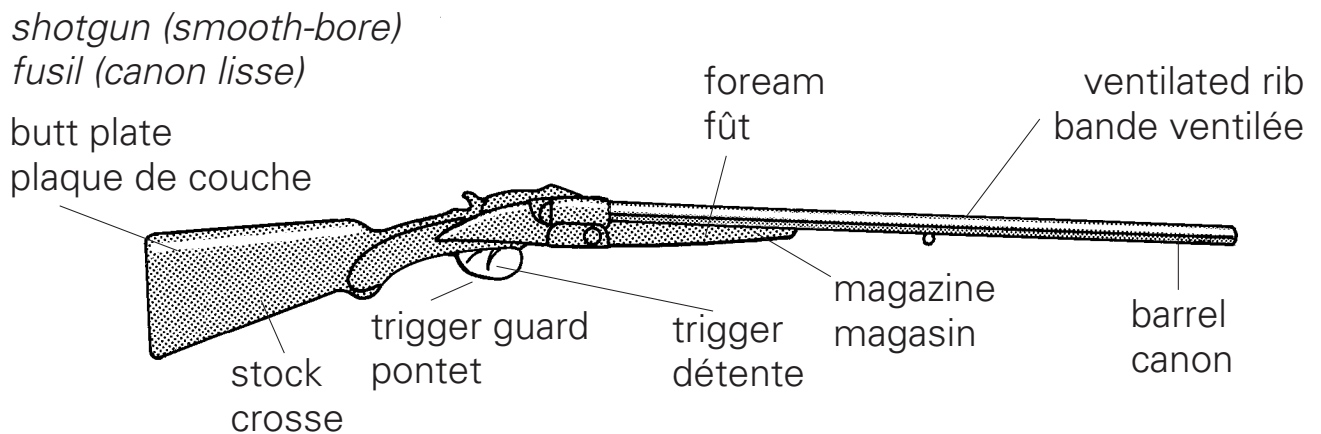
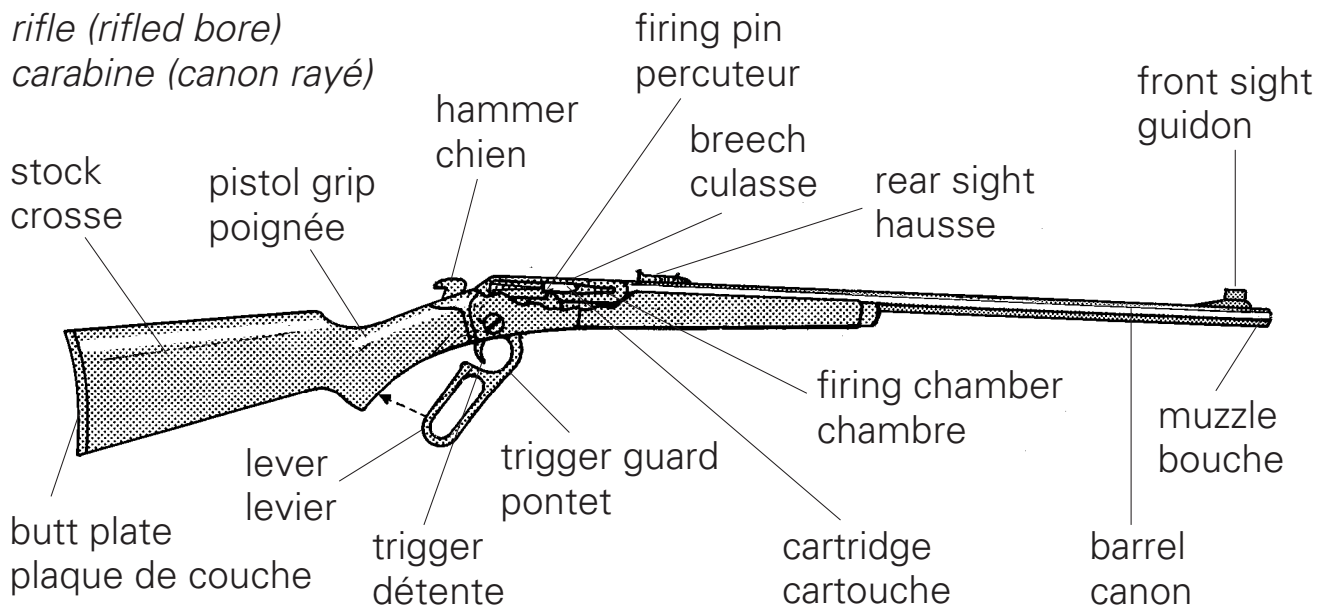
HUNTING WEAPONS
ARMES DE CHASSE

STATIONERY
ARTICLES DE BUREAU

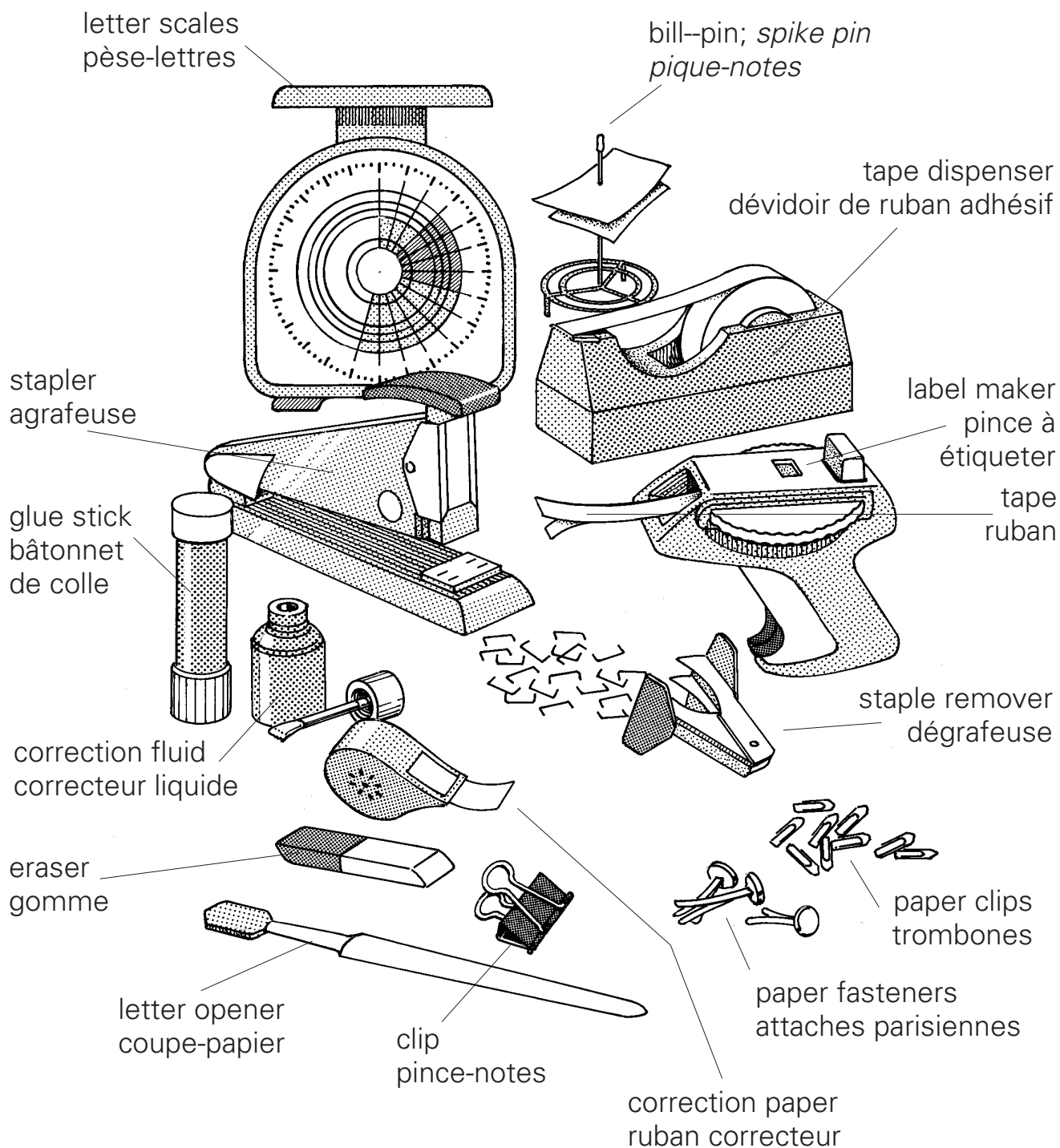

MOUNTAIN
MONTAGNE

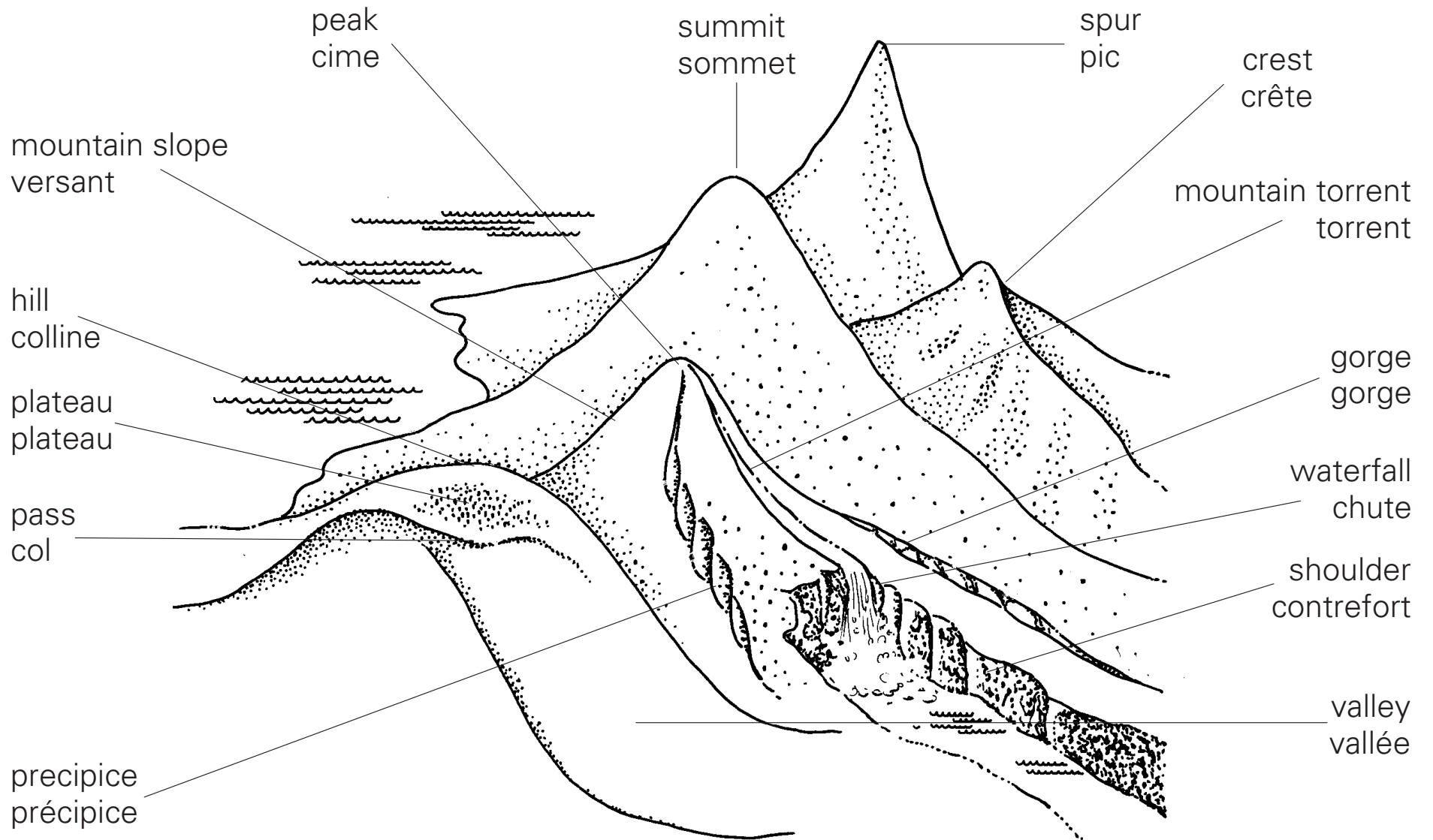

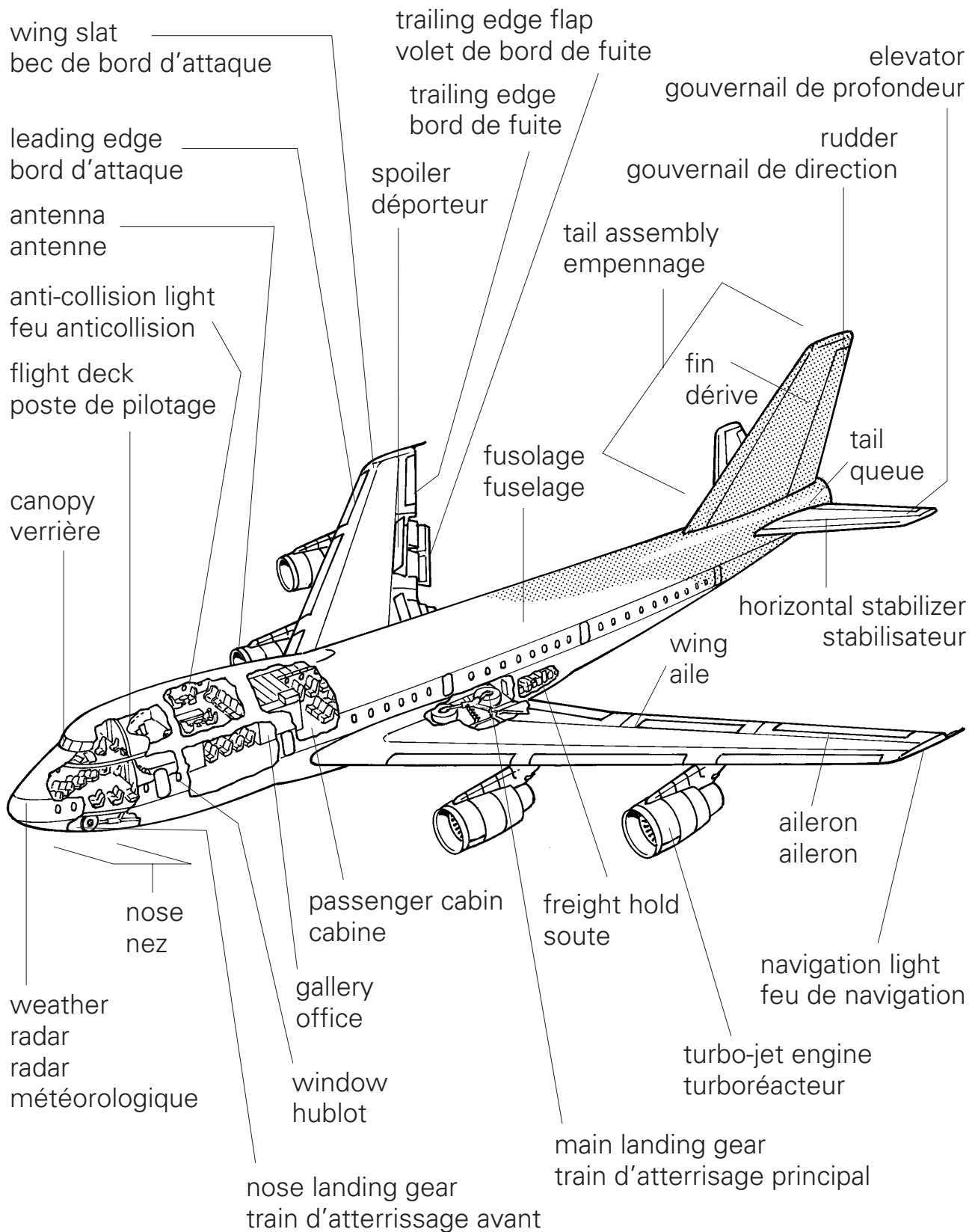
LONG-RANGE JET
AVION LONG-COURRIER

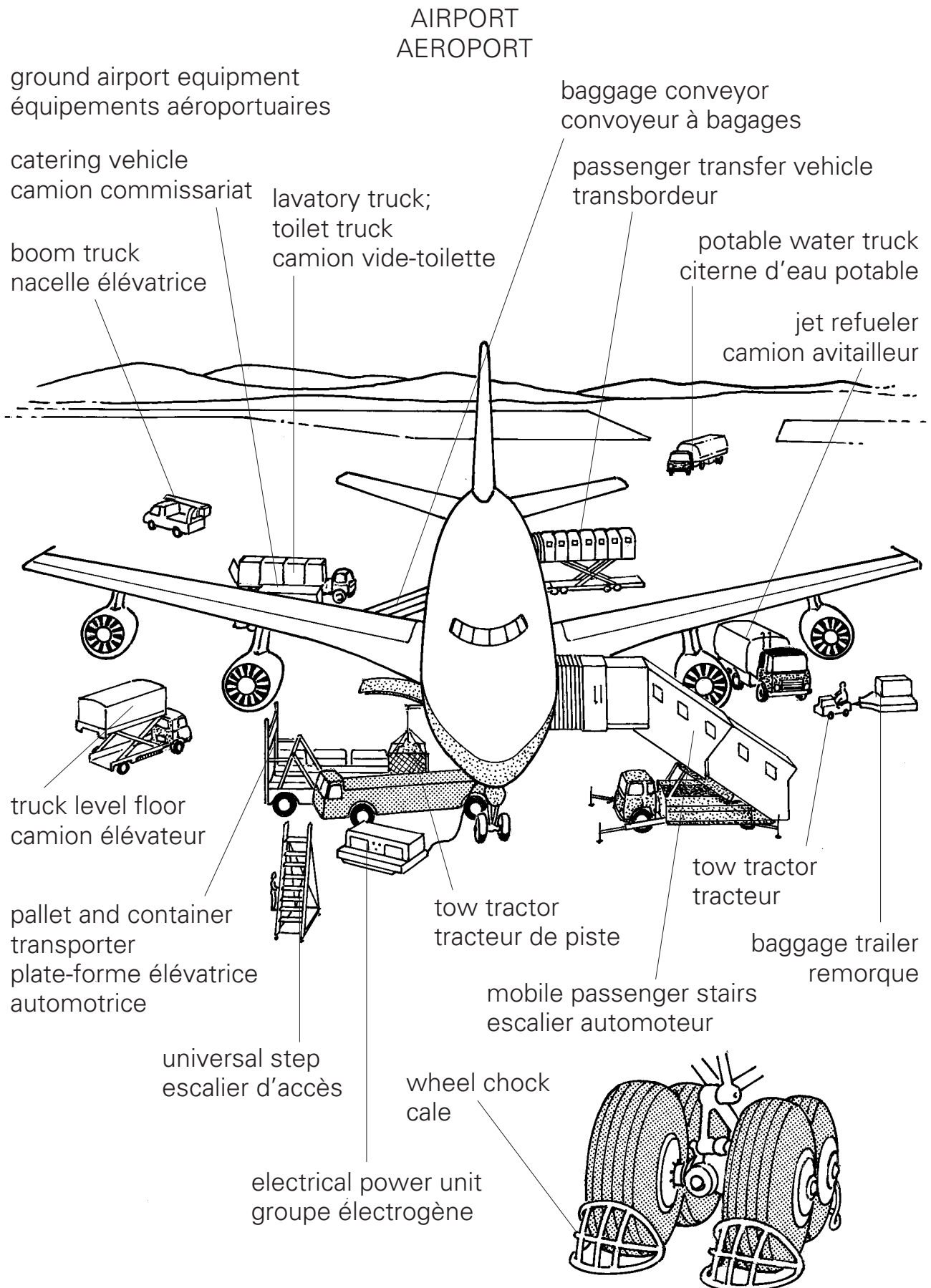

PASSENGER TERMINAL
AEROGARE DES PASSAGERS

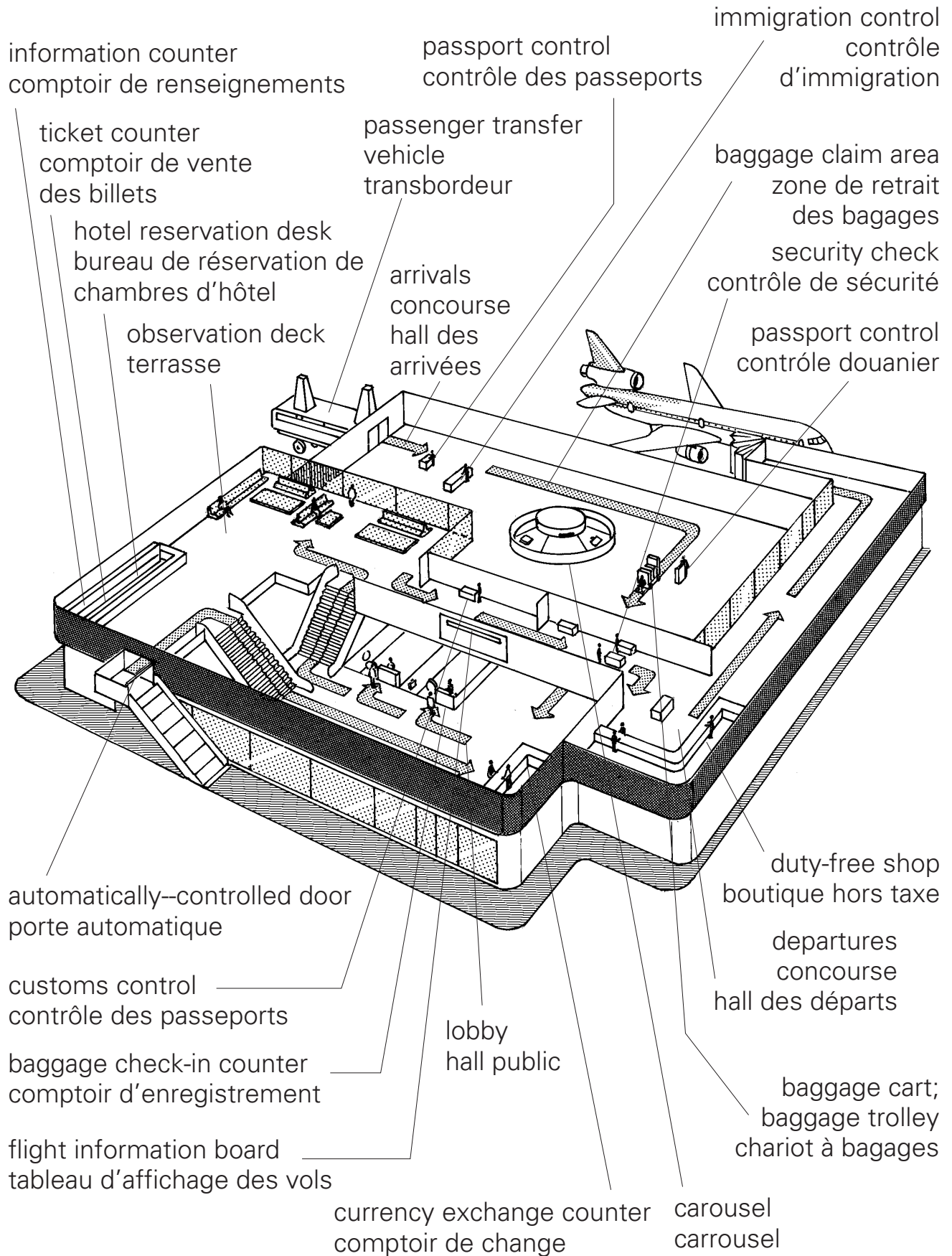

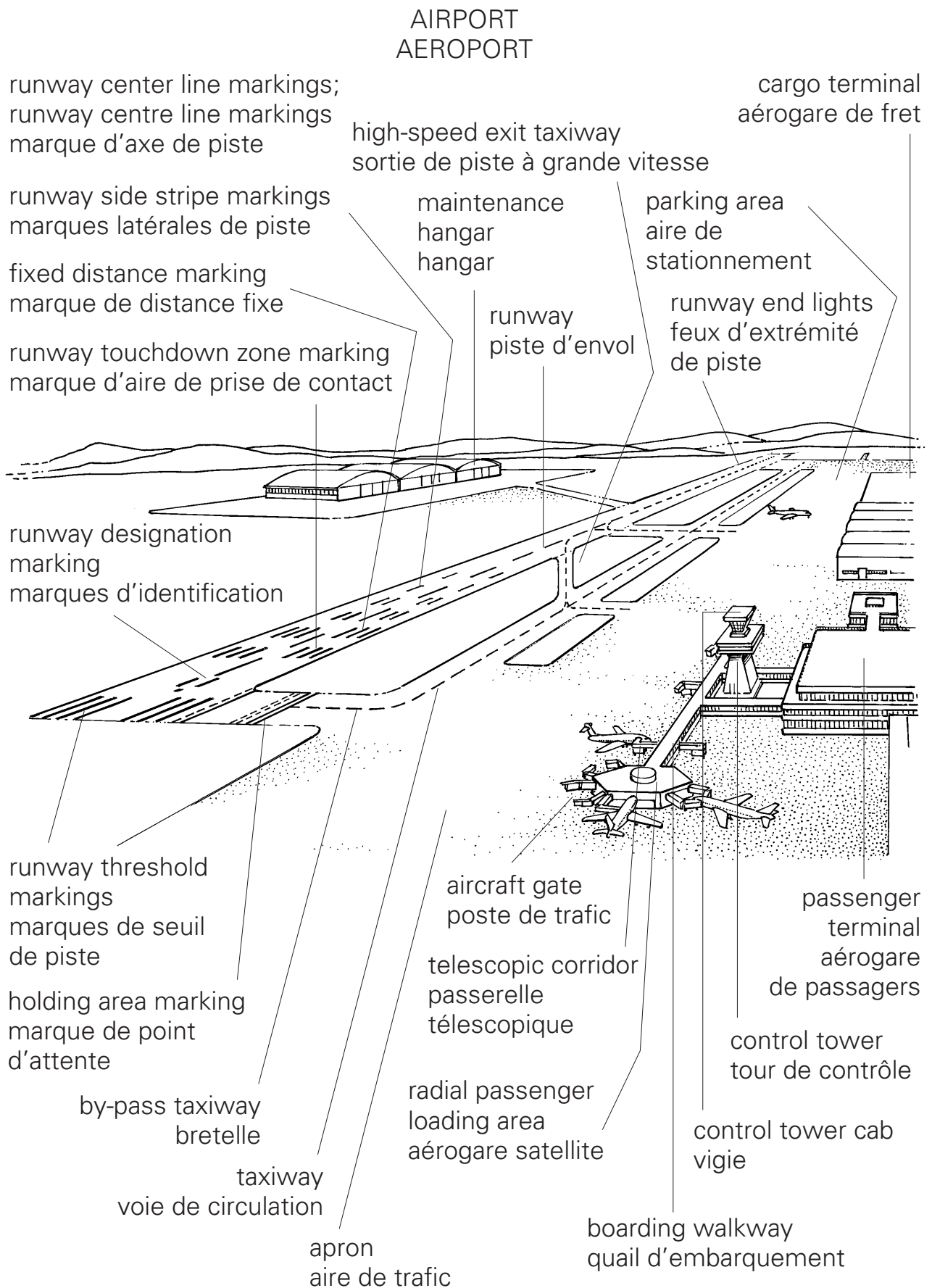

AUTOMOBILE; CAR
AUTOMOBILE

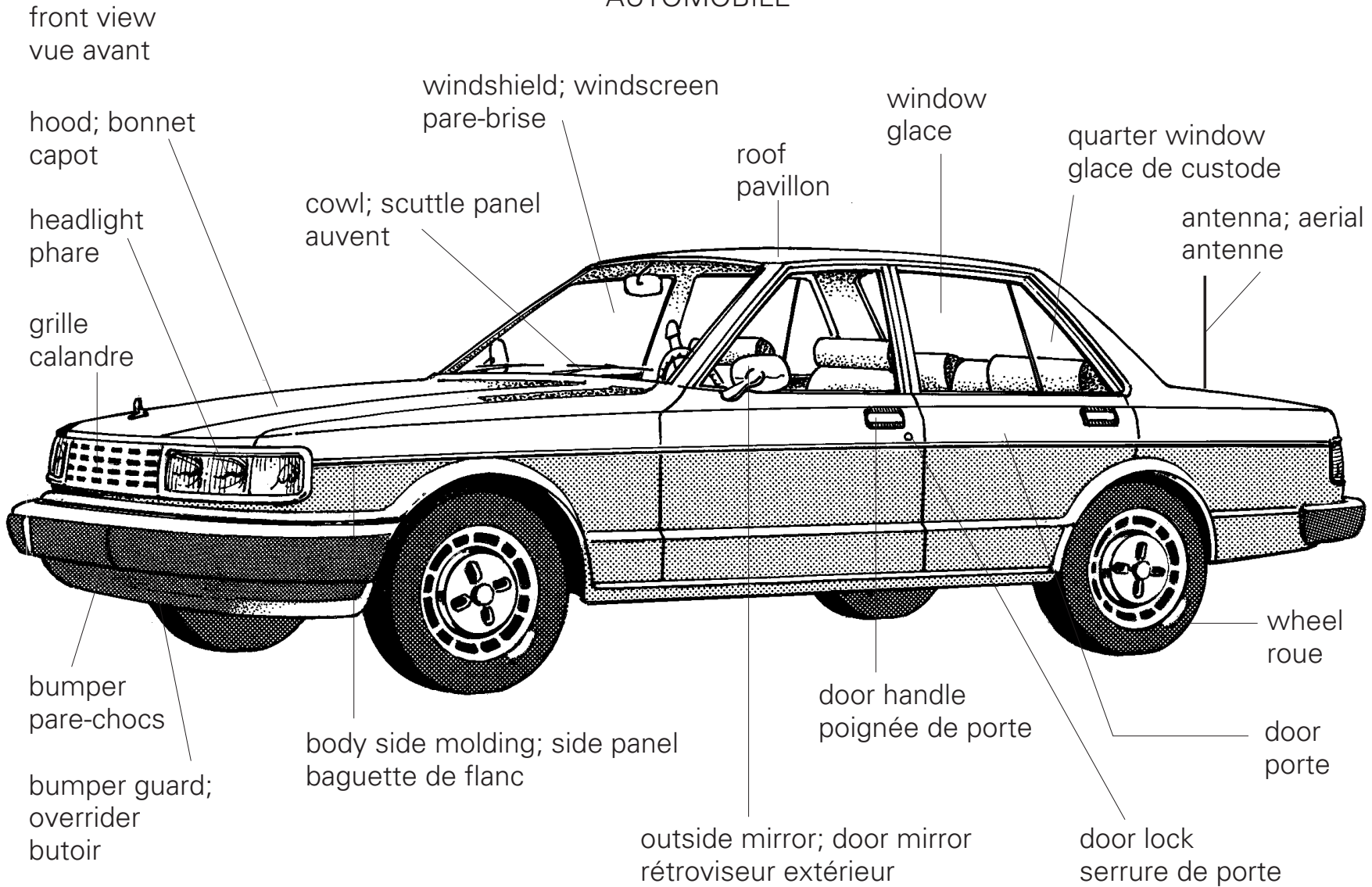

front view
vue avant

hood; bonnet
capot

headlight
phare

grille
calandre

bumper
pare-chocs

bumper guard;
overrider
butoir

windshield; windscreen
pare-brise

cowl; scuttle panel
auvent

body side molding; side panel
baguette de flanc

roof
pavillon

window
glace

door handle
poignée de porte

outside mirror; door mirror
rétroviseur extérieur

quarter window
glace de custode

antenna; aerial
antenne

wheel
roue

door
porte

door lock
serrure de porte

REAR VIEW
VUE ARRIERE

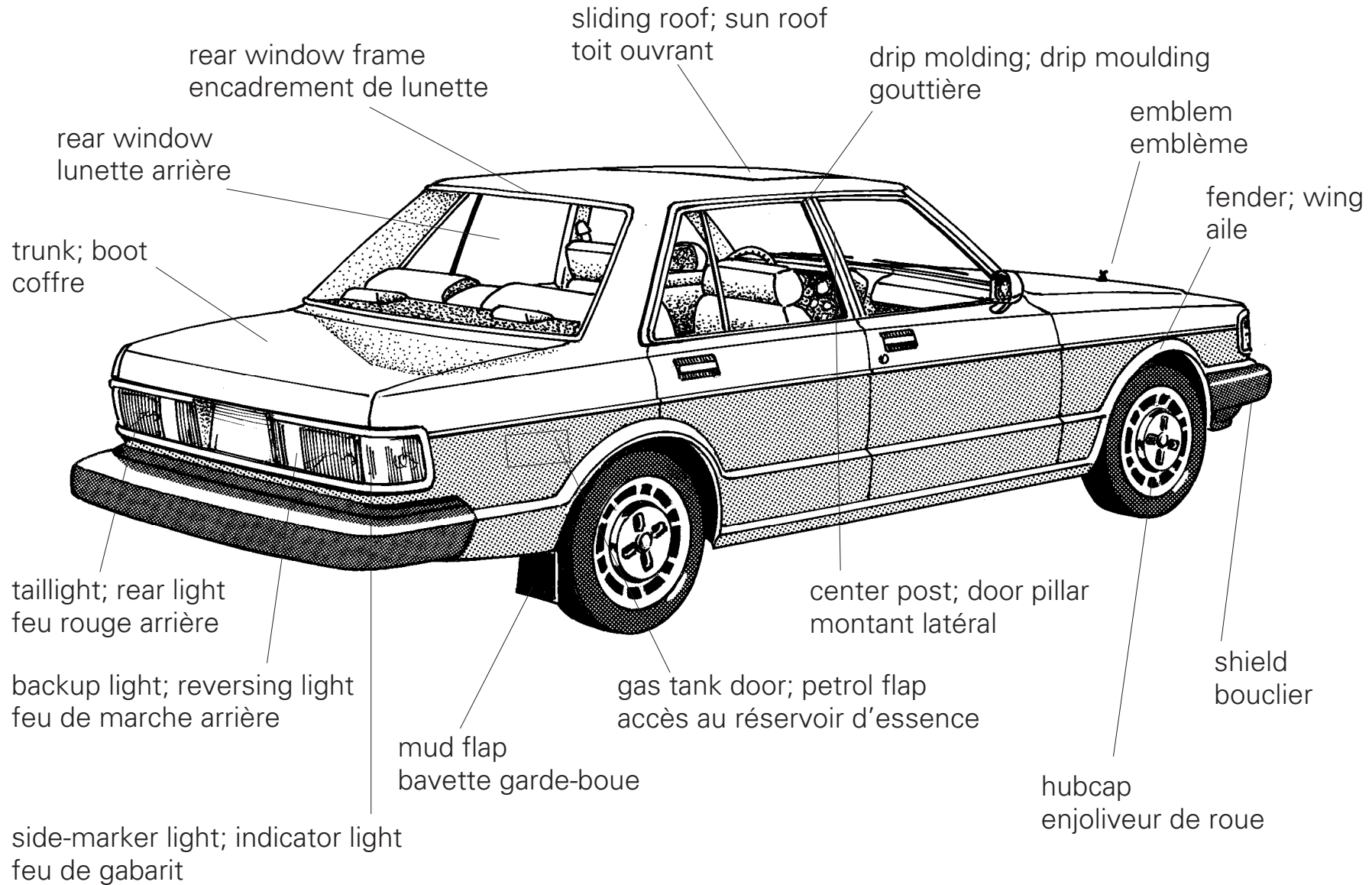

AUTOMOBILE; CAR
AUTOMOBILE

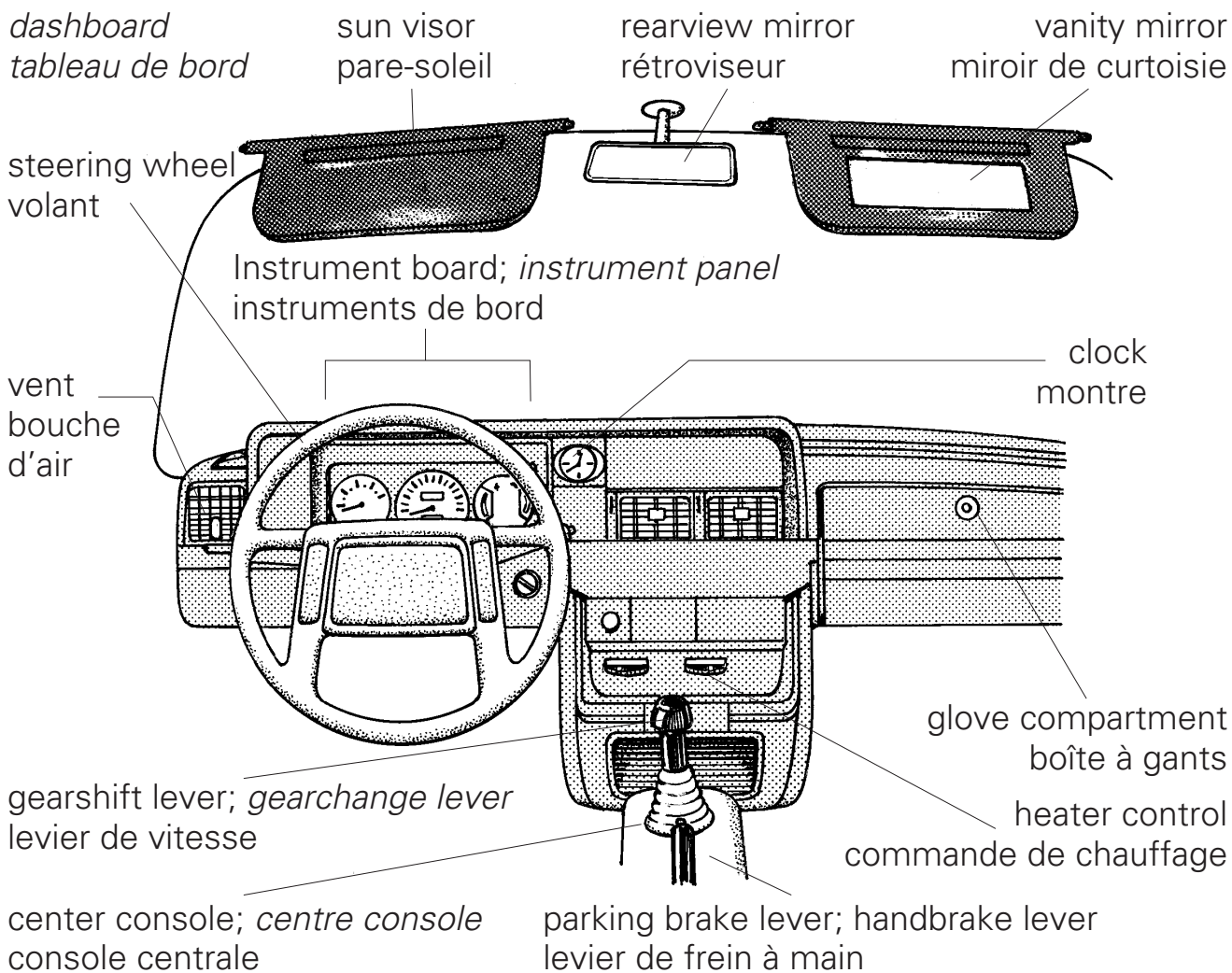

Instrument board; instruments panel
instruments de bord

revolution counter
compte-tours

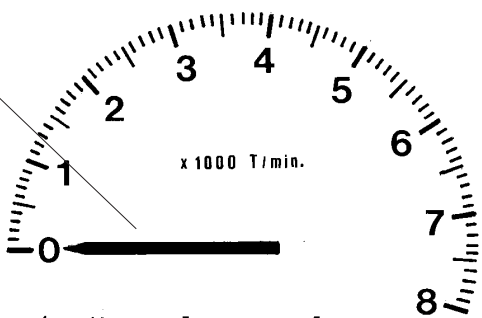

Alternator indicator
indicateur de charge

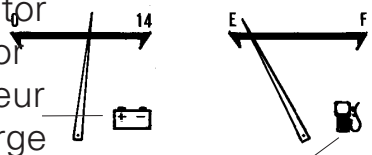

fuel indicator
indicateur de niveau de carburant

speedometer
indicateur de vitesse

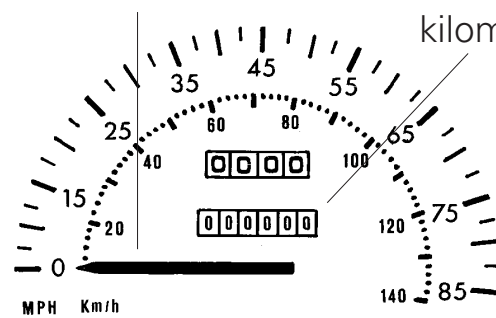

odometer
compteur kilométrique

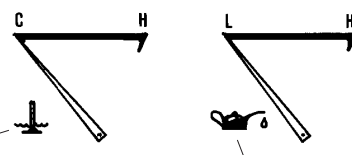

temperature indicator
indicateur de température du liquide de refroidissement

oil indicator
indicateur de niveau d'huile

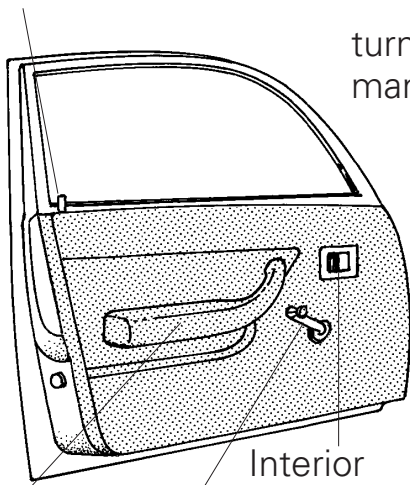
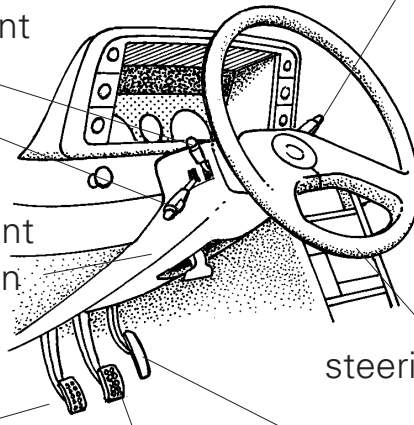
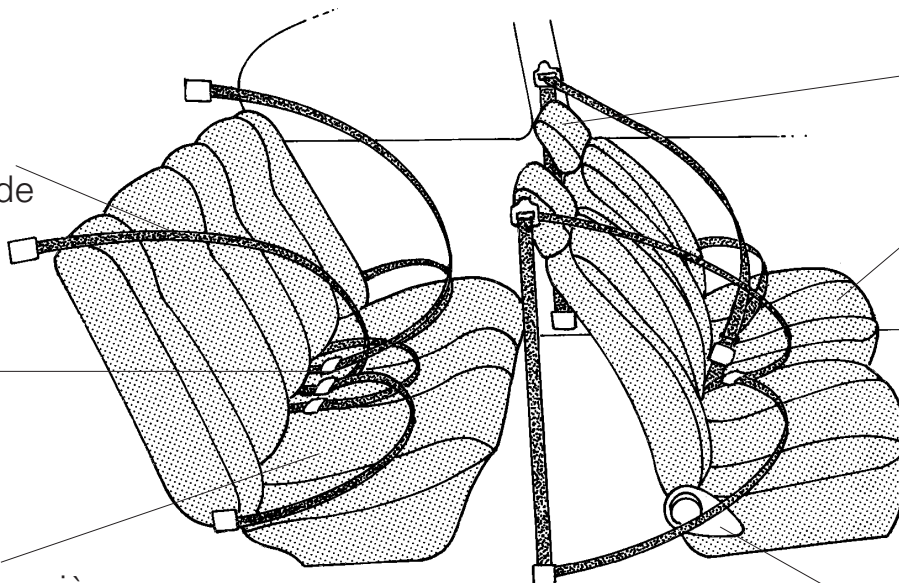
AUTOMOBILE; CAR
AUTOMOBILEdoor
porteinterior door lock button
bouton de verrouillagearm rest
accoudoirInterior
door handle
poignée
intérieurewindow regulator handle; *window winder handle*
manivelle de lève-glaceturn sign lever; *indicator switch*
manette de clignotantdimmer switch
dip switch
inverseur
route-croisement
steering column
colonne de
directionclutch pedal
pédale de
débrayagebrake pedal
pédale de freingas pedal;
accelerator pedal
pédale d'accélérateursteering
directionwiper switch
commande d'essuie-glacesteering wheel
volantseats
siègesseat belt
ceinture de
sécuritébuckle
bouclerear seat
banquette arrièrebackrest, *squab*
dossierrelease handle
commande de dossierheadrest
appui-têtebucket seat
siège-baquet